

Profili architettonici

P1

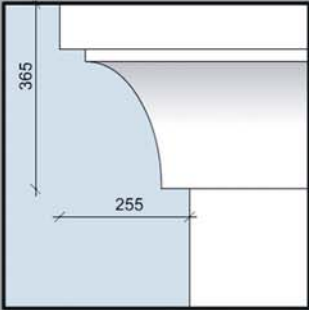

P2

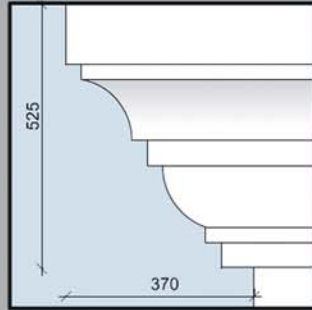

P3

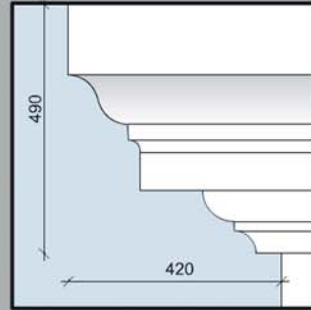

P4

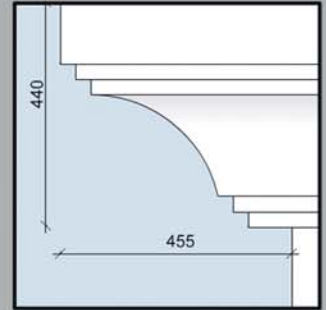

P5

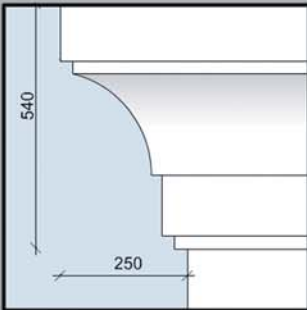

P6

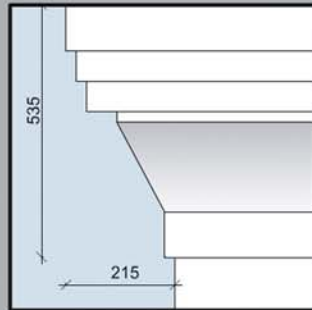

P7

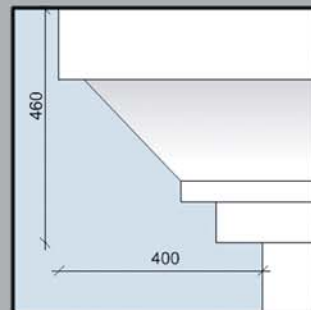

P8

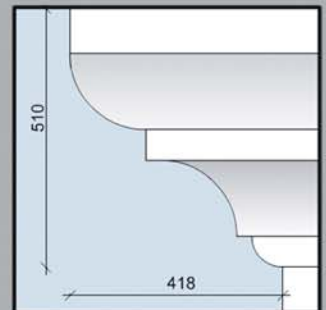

P9

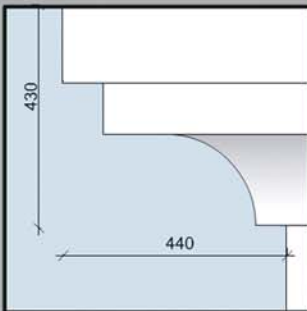

P10

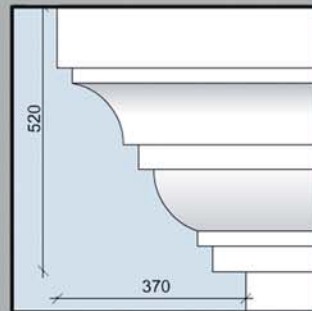

P11

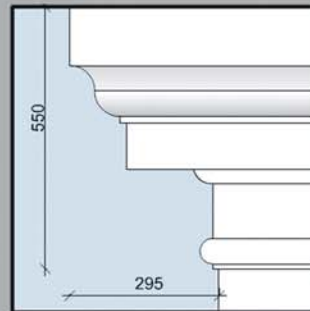

P12

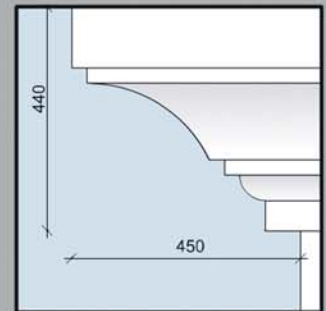

P13

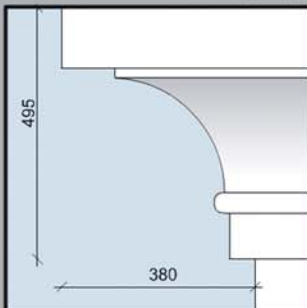

P14

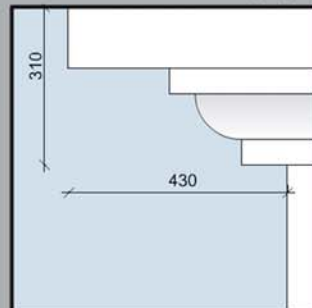

P15

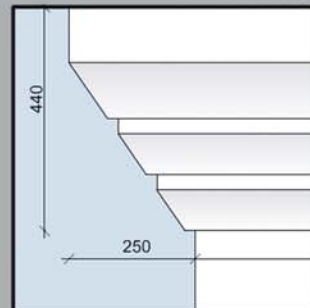

P16

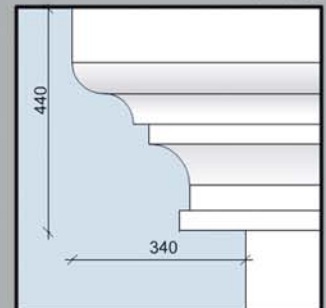

isoltop

Profili architettonici

P17

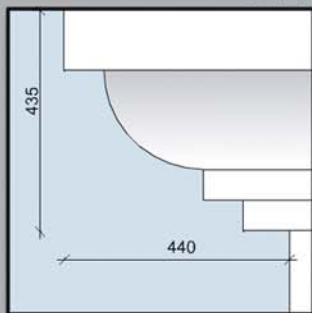

P18

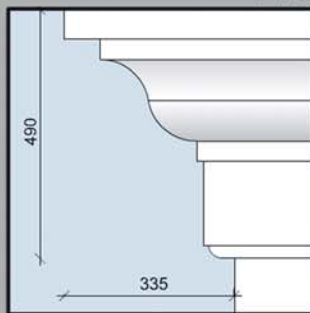

P19

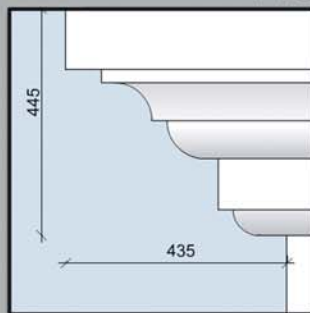

P20

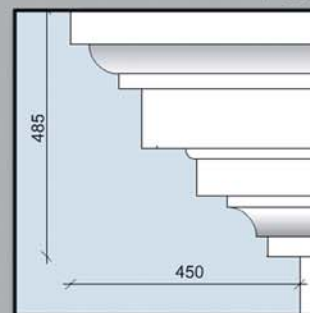

P21

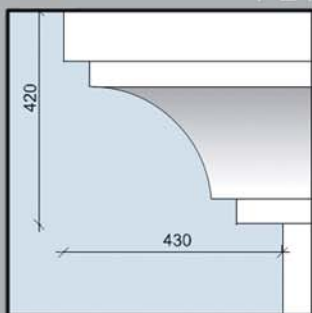

P22

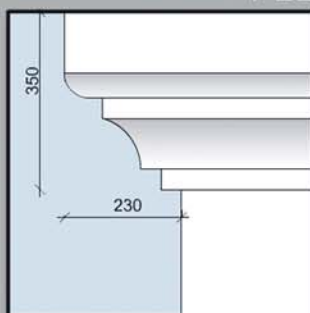

P23

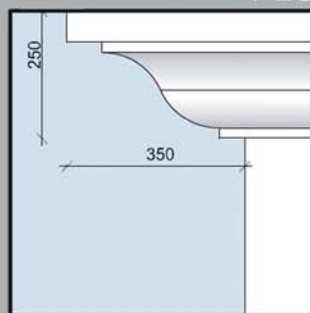

P24

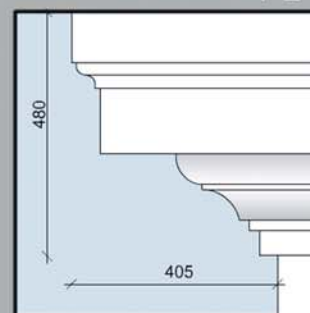

P25

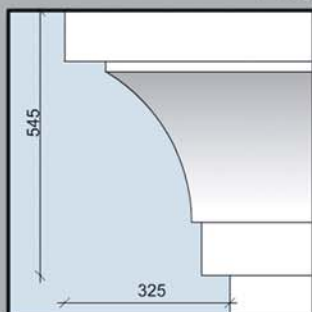

P26

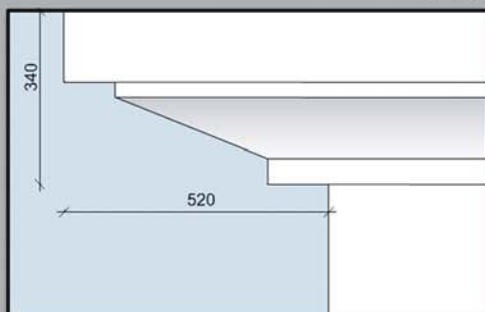

P27

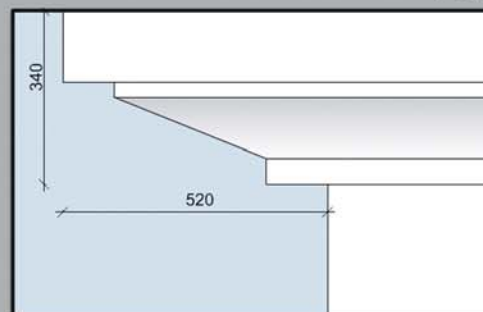

P28

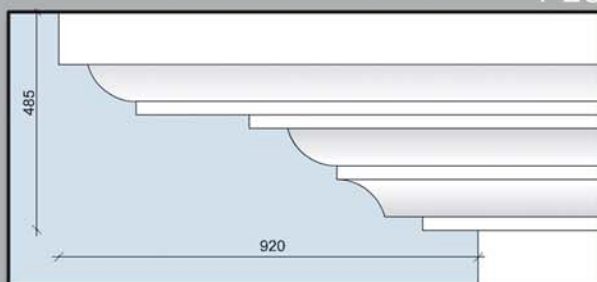

P29

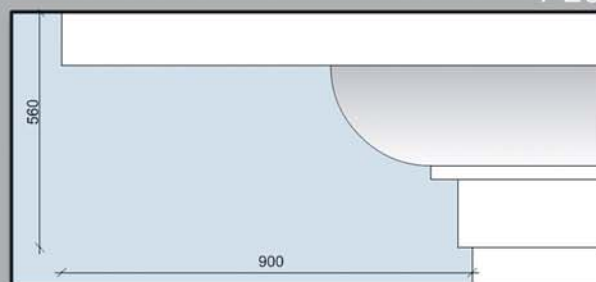

P30

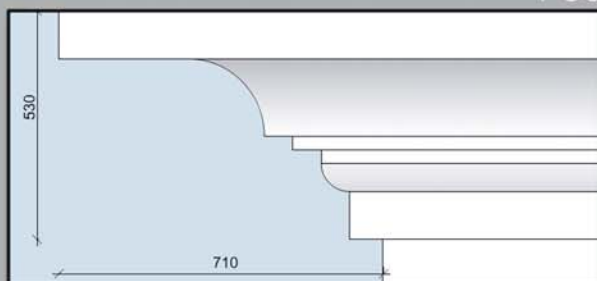

P31

